

CLIMAVER[®] DUCT SYSTEM

More than a duct.
Much more than insulation.

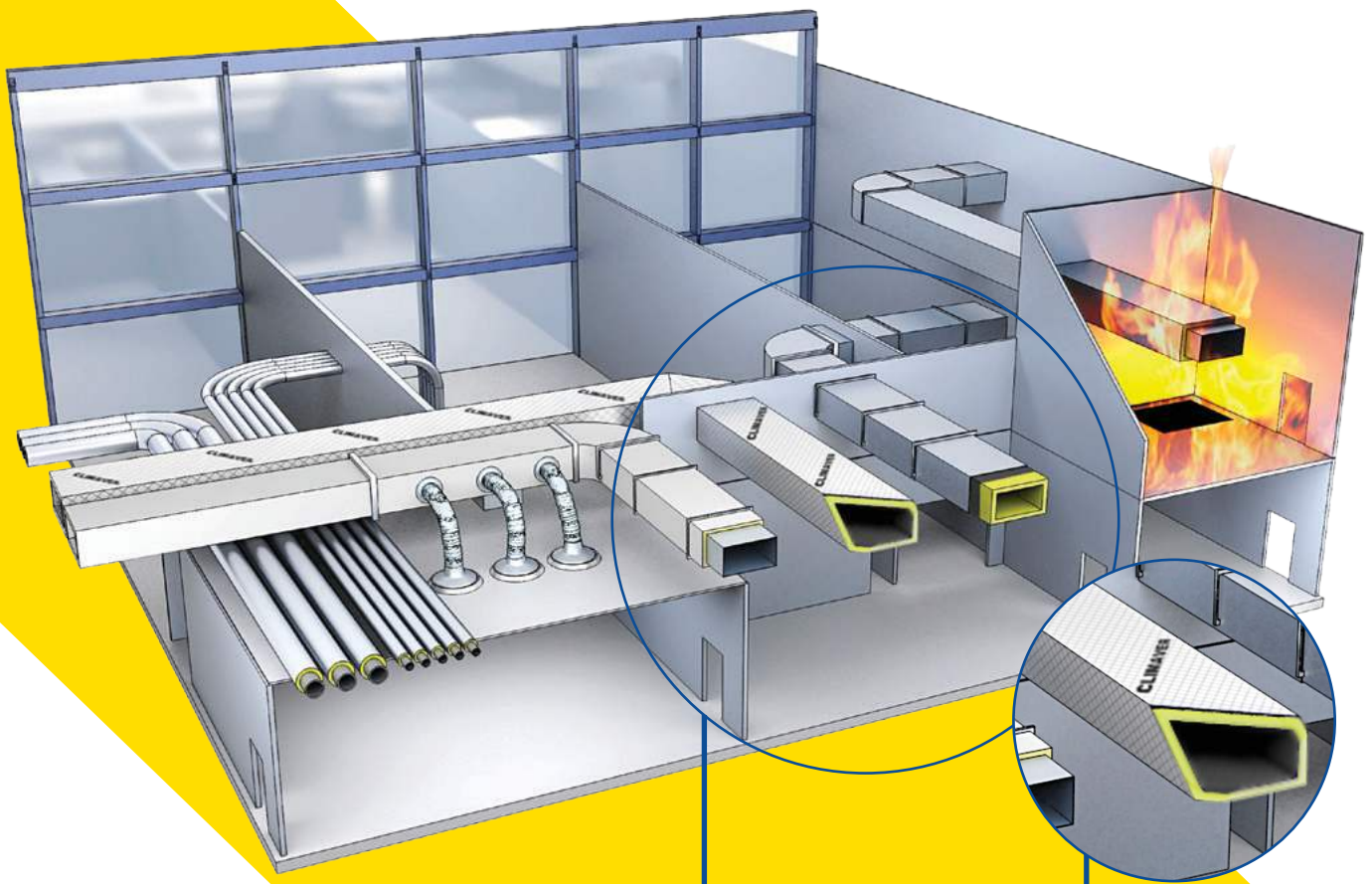

Inside your HVAC SYSTEM



Ventilation/
air-conditioning
system

Self-supporting
duct system
CLIMAVER®

Optimizing VENTILATION & AIR-CONDITIONING SYSTEMS

Do you want to optimise your projects by offering your customers the most efficient solutions for their ventilation and air conditioning systems?



Increase the energy efficiency of buildings by offering best in class duct systems



Reduce installation, operating and maintenance **costs**



Provide the right amount of fresh air and ensure thermal and acoustic **comfort** for the occupants

CHOOSE CLIMAVER®, YOUR ALL-INCLUSIVE DUCT SYSTEM

Made from dense and rigid glass wool boards, CLIMAVER® self-supporting air ducts are a cost-effective, easy-to-install alternative to traditional insulated metal ducts:



An all-in-one metal-free system, delivered flat on a pallet, and assembled in a single operation.



Duct sections are assembled easily, without the need for expensive machinery usually used on-site.



A shiplap on the edges ensures tight closure of the duct.

A unique product to replace metal ducts, providing state-of-the-art insulation and comfort.

Read more to find out how CLIMAVER® ductwork can make your buildings more cost-efficient, greener and safer...

Add value at **EVERY STEP OF THE PROJECT**

Invest in this exceptional ducting solution to add value across the entire life of the project.



AS A BUILDING OWNER

- › Do your bit for the environment
- › Improve the safety, comfort and wellbeing of the occupants of your property
- › Earn points towards Green Building certifications (LEED, BREEAM...)
- › Significantly reduce operational and maintenance costs



AS A SPECIFIER

- › Design high-performance ventilation & air-conditioning systems for your customers
- › Bring key benefits to your customers
- › Demonstrate your capacity to innovate
- › Address the most stringent building regulations (thermal, acoustic & fire performance)
- › Work with Building Information Modelling (BIM)



AS A CONTRACTOR

- › Install duct and insulation in a single operation
- › Reduce installation time and labour costs
- › Install more easily
- › Optimise your logistics

8 GOOD REASONS TO CHOOSE CLIMAVER®

Reduce your energy bill

Get greener

Engage for safer and healthier materials

Keep the noise down

Ensure fire safety

Ensure reliable, long-term performance

Minimise maintenance

Increase your site productivity

Reduce your ENERGY BILL



To make your duct system as energy efficient as possible, you must take into consideration the thermal performance of your insulation material, potential thermal bridges and the airtightness of the duct system.

THE ALL-INCLUSIVE CLIMAVER® SOLUTION

Highest classification of airtightness (exceeding the most stringent airtightness classification)

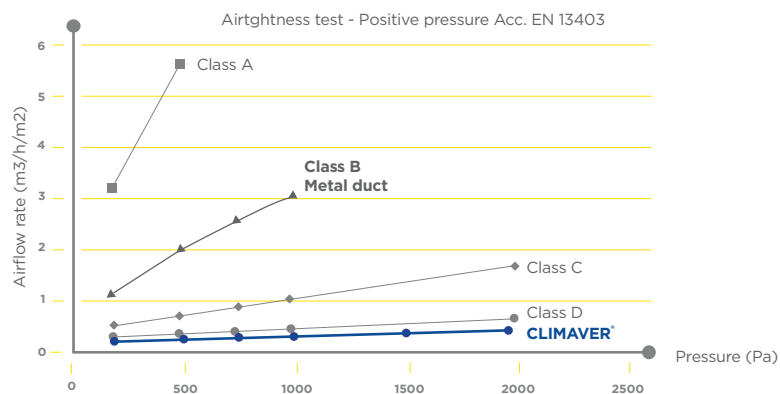

Excellent thermal resistance

Thermal conductivity at 10°C (W/ m.K)

$$\lambda = 0,032$$

Thermal Resistance (m².K/ W)

$$R = 25\text{mm} = 0.78$$

$$R = 40\text{mm} = 1.25$$



Reduced thermal bridges



Reduced thickness of insulation at the edges



Thermal bridges + risk of condensation

Constant thickness of insulation all around the duct



No thermal bridges



Are you aware of the untapped potential of airtight ducts to improve energy efficiency?

Most people are unaware of this “out-of-sight” problem around the seams and joints of duct take-offs and fittings, often due to a poor workmanship. In fact, duct leakage is not only detrimental to indoor air quality and comfort, but also to the energy efficiency of the whole system.



Reducing leakage means:

- **Less heat loss.**
- **Less power for air handling unit (AHU) or ventilation machine needed** to compensate for the effect of the leaks.
- **Lower total airflow** rates to and from unconditioned spaces.
- **Optimised energy efficiency measures**, including demand-control and heat recovery.
- **The air** needed to maintain the indoor environment at the desired temperature **flows exactly where it is needed.**
- The whole system can be **precisely dimensioned.**

Energy used for heating & cooling is reduced by ~15%.

SCENARIO:

- › A duct system of 200m², with a static pressure of 300 Pa, and a flow of 5400 m³/h.
- › The airflow temperature is 16 °C and the room temperature is 25°C.
- › Energy cost assumed is 0.15 EUR per kWh.

Airtightness class EN 13403	Leaks permitted (l/(sm ²))	% Leaks/total flow	Energy loss / year (kWh)	Cost / year (EUR)
A	1.1	14.8	21283	3192
B	0.370	5.0	7030	1055
C	0.120	1.6	2343	351
D	0.040	0.5	780	117
CLIMAVER®	0.017	0.2	330	50

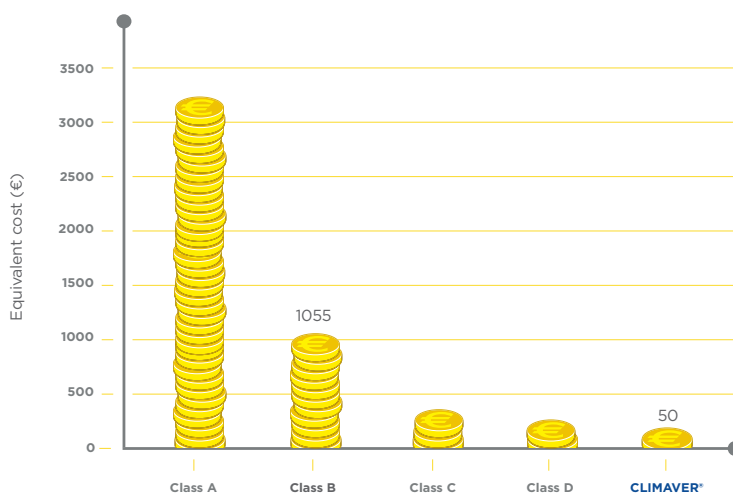
Cost per year due to duct leakage**Class B system
(metal duct + insulation)**

- › Up to 5% leaks / total flow
- › Up to 7030 kWh lost per year
- › **Cost of duct leakage = 1055 €**

VS.**CLIMAVER®**

- › Max 0.2% leaks / total flow
- › Only 330 kWh lost per year
- › **Cost of duct leakage = 50 €**

Get GREENER



Are you looking for more sustainable solutions?

CLIMAVER® provides various benefits to the environment across its entire lifecycle, lessening the impact from sourcing to manufacture, from distribution to end-of-life:



CLIMAVER® helps save materials & resources:

Manufactured from up to 80% recycled glass wool, it reduces the need for sand extracted from quarries and helps protect biodiversity. But that is not all! Compared to metal ducts requiring the use of screws and welding, CLIMAVER® also reduces the consumption of additional tools and equipment.



CLIMAVER® drives energy efficiency:

Very good thermal resistance, reduced thermal bridges and excellent airtightness help significantly reduce energy consumption and limit greenhouse gas emissions from your ventilation system. *Remember: The best energy is the energy we don't use.*



CLIMAVER® limits waste generation:

The exclusive Straight Duct Method (cf. page 18) and unique guiding lines ensure the optimal use of material, reducing building site waste.



CLIMAVER® reduces transport emissions:

The product is usually delivered flat on a pallet and assembled on-site. CLIMAVER®'s space-saving packaging reduces and optimises transport-related emissions.



Do you expect your suppliers to be transparent about the impact of their products?



At ISOVER, we assess the environmental impacts of our products over their entire lifecycle (**LCA - Life Cycle Assessment**). We also offer transparent information on their environmental performance to our customers by providing third-party verified **Environmental Product Declarations**. EPDs for CLIMAVER® are available on our website.

For a typical office building, the use of 1000m2 of CLIMAVER® instead of insulated metal duct would save the equivalent of:



More than 36 years of driving 20km a day to work*
180,000 km travelled by car
or 30 tons of CO2 emissions



The electricity usage of 4,000 inhabitants for 24h**
215,000 MJ of electricity consumed over 25 years

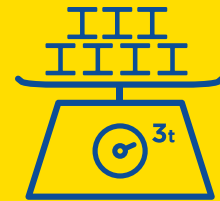

More than 3 tons of steel to install, insulate and dismantle



CLIMAVER® contributes significantly to many aspects of LEED and other sustainability labels.

Engage for safer AND HEALTHIER MATERIALS



The health and safety of our customers is a top priority for us, not only for the building's occupants, but also during installation.

PROVIDING FRESH, CLEAN AIR

The indoor climate of the buildings is important for the wellbeing of its occupants. A constant supply of clean, fresh air helps people to be more productive, happier and to experience fewer health issues. The best way to improve indoor air quality is to reduce pollution at source while improving ventilation and purifying the air. With CLIMAVER®, you can effortlessly carry fresh air inside **without having to worry about mould or bacteria** (EN 13403 for non-metallic ducts). CLIMAVER® also fulfils low emission requirements for buildings (according to EN ISO 16000-10:2006).



WORKING WITH A SAFE MATERIAL

CLIMAVER® ensures safe and comfortable installation

All ISOVER glass wool fibres are bio-soluble and exonerated from any classifications on carcinogenic, mutagenic, or toxic for reproduction criteria. CLIMAVER® is certified according to EUCEB and therefore complies with all EU regulatory requirements.



CLIMAVER® is easy to handle thanks to its ergonomic product dimensions and **weight 50% lower** than a metal duct + insulation solution.

In addition to this, the aluminium foil with its unique guiding lines improves installation productivity.

More than 2500 scientific publications have demonstrated that mineral wool fibres are safe to manufacture, install and live with. This has been recognised by health authorities at an international level e.g. REACH regulation.

Keep the noise DOWN



Noise is recognised as an environmental pollutant that has a significant impact on our health and wellbeing. Ventilation and air-conditioning systems can be a source of noise and vibrations, either from the equipment itself or from the air flow circulating through the system.

Main sources of noise in a ventilation and/or air-conditioning system:

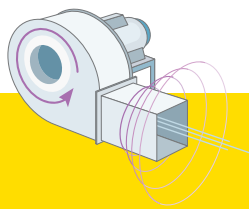

Ventilation/ air-conditioning system

Noise transmission due to the ventilation and/or air-conditioning system itself.

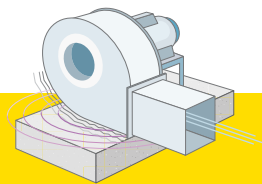

Machinery vibrations

Noise transmission due to the structure on account of vibration.

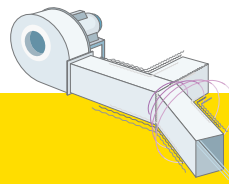

Air circulation

Generation of noise by the air speed effect.

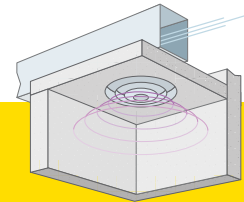

Grilles and diffusers

Noise transmission via grilles and diffusers.

This phenomenon is particularly noticeable if the internal surface of the ducts is made of a material that easily reflects sound, e.g. metal.



Create a well-balanced acoustic environment with CLIMAVER®

CLIMAVER® offers best-in-class sound absorption with weighted absorption coefficients of up to α_w 0.85 for CLIMAVER® Neto and α_w 0.90 for CLIMAVER® APTA.

Acoustic absorption (α_w)

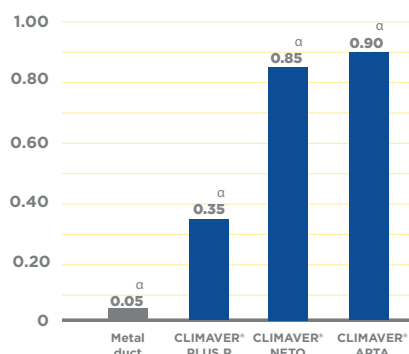

It acts as a sound insulator both towards its surroundings, and within the ductwork:

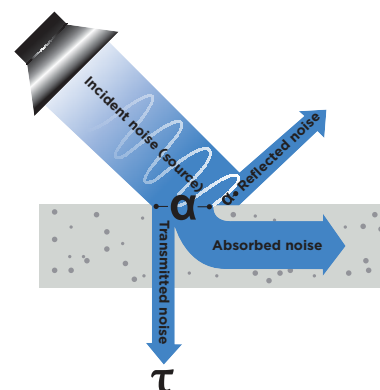

Product	Frequency (Hz)				
	125	250	500	1000	2000
Metal duct	2	2	7,5	7,5	3
CLIMAVER® Plus	8.5	8.5	8.5	38.5	30
CLIMAVER® Neto	18	43	52.5	62.54	68
CLIMAVER® Apta	22	43	53	68	68

Acoustic attenuation in dB for 5m of 400x200mm duct

CLIMAVER® is highly absorbent, including at low frequencies, where the problem of noise generated by the AHU or ventilation machine is greater.



Increases the level of acoustic comfort of your buildings

No need for additional acoustic insulation liners inside the ducts

No need for silencers or sound attenuators*

**depending on system design*



Ensure FIRE SAFETY



The consequences of fire breaking out and spreading are of serious concern for property owners and occupants everywhere.

Today's buildings are full of highly inflammable materials which immediately catch fire. Within only a few minutes, a fire spreads, meaning the temperature goes up and the room begins to fill with toxic smoke. Smoke inhalation can cause serious respiratory complications, and is the primary cause of death for victims of fires, exceeding burns by a 3-to-1 ratio.

The choice of materials can significantly affect the spread of fire and its rate of travel, even though they are not likely to be the first things to ignite. They can be classified in terms of their reaction to fire, i.e. their potential contribution to flashover (the spontaneous ignition of hot smoke and gases which can lead to a fire spreading uncontrollably). To address other hazards found in real-life fires and for risk assessment, two additional classifications are also available: "s" and "d", providing information on smoke development. Class s1 to s3 refers to levels of smoke release, from insignificant (s1) to high (s3); and classes d0 to d2 refer to the emission of flaming droplets.

Product CLIMAVER®	Class	Reaction to fire	Flashover	Smoke and droplets
A1 APTA	A1	No contribution to a fire	No	None
A2 PLUS, A2 NETO, A2 DECO, A2 APTA	A2, s1-d0	No significant contribution to fire growth	No	Insignificant smoke release with no flaming droplets or particles expected
PLUS R, NETO, APTA, STAR	B, s1-d0	No significant contribution to fire growth	No	Insignificant smoke release with no flaming droplets or particles expected
-	C	Limited contribution to flashover	Flashover >10 min	Production of smoke & flaming droplets & particles
-	D	Contribution to flashover	Flashover 2<>10 min	Production of smoke & flaming droplets & particles
-	E	Significant contribution to flashover	Flashover <2 min	Production of smoke & flaming droplets & particles (smoke release is expected to be substantial)
-	F	Not tested or incapable of achieving Class E	NPD	NPD

CLIMAVER® is also classified O according BS 476 standard.

**SAFETY FIRST:**

CLIMAVER® is non-combustible. It does not contribute to the spread of fire. It will not emit smoke or help to propagate fire.

Ensure reliable, **LONG-TERM PERFORMANCE**



As CLIMAVER® is made of glass wool, it could be perceived as fragile. However, CLIMAVER® is both robust and flexible, which means that it can withstand all kinds of mechanical stress.

WITHSTANDING HIGH PRESSURE

To make sure your CLIMAVER® duct is not affected by the working pressure of your air conditioning system, we tested the entire range in accordance with EN 13403.

The Resistance Against Pressure test determines the fitness for purpose of ductwork assembled without reinforcements. The air ducts and connector sections with joints should withstand the test pressure without rupturing.

This standard requires the duct to be tested at a pressure of 2.5 times the pressure declared by the manufacturer. The CLIMAVER® range has therefore been tested at a pressure of 2000 Pa without generating any cracks or swelling, despite the test being performed on a joint between two ducts.

Be assured that your CLIMAVER® duct can withstand constant static pressure of up to 800 Pa and air-circulation up to 18m/s.

A ROBUST SYSTEM

CLIMAVER® has been tested for the minimum required rigidity according to the EN 13403 method. It attains board stiffness Class R2 (Flexural rigidity $Nmm^2 \geq 90,000$).

Contrary to metal ducts, CLIMAVER® is not at risk of dents or damage on building sites.



Minimise **MAINTENANCE**

We know that it is important for your ventilation to work efficiently over time. Our design teams have therefore worked hard to ensure all CLIMAVER® products are easy to clean without compromising their original properties.

The internal coatings of the CLIMAVER® range offer the mechanical resistance required to clean the air conditioning systems, including with nylon brushes, without causing any deterioration or requiring post-cleaning treatments (encapsulation). For the same reason, the resistance of the internal coating reduces the frequency of access required for cleaning. This has been certified by AELSA (the Spanish association of duct cleaning companies).

CLIMAVER® ducts retain all their acoustic, thermal and fire protection properties over the whole lifetime of the system.



Increase your SITE PRODUCTIVITY



Do you want to optimise your work, increase productivity and reduce installation times?

Choose CLIMAVER®, a single product that replaces the two traditional trades of metal ductwork and their insulation. Assembled in a single operation, it offers numerous installation benefits:



Improves site productivity:

CLIMAVER® is up to 5 times faster to install than metal ducts + insulation. One worker can install 20 to 25 m² of CLIMAVER® per day, which can help optimize the use of manpower.



Greater flexibility:

Installed on site, CLIMAVER® can easily be adapted to last-minute changes in ductwork or alternative routing.



Comfortable to install:

Up to 50% weight reduction compared to metal ducts + insulation, and its ergonomic product dimensions make it easy to carry and lift. Installation also requires fewer duct supports.



Optimises logistics:

Saves space during transport and storage, as CLIMAVER® is delivered flat on a pallet or box, and no special power tools or machines are needed for installation.



Limits waste generation



Reduces noise disturbance on building sites.

UNDERSTANDING THE SDM METHOD

As its name suggests, the Straight Duct Method (SDM) involves combining straight duct boards in different configurations and parts like elbows, branches and offsets etc.

By constructing self-supporting ducts in this way, greater precision, resistance and quality can be achieved, with less load loss and waste.

What's more, you'll save time and money, as the boards are faster to install.

5 times faster than cutting from pieces.

We've added guiding lines on all CLIMAVER® boards, so the installer does not have to draw lines himself. This limits the risk of mistakes, while improving performance and optimising the quantity of material used.

New design

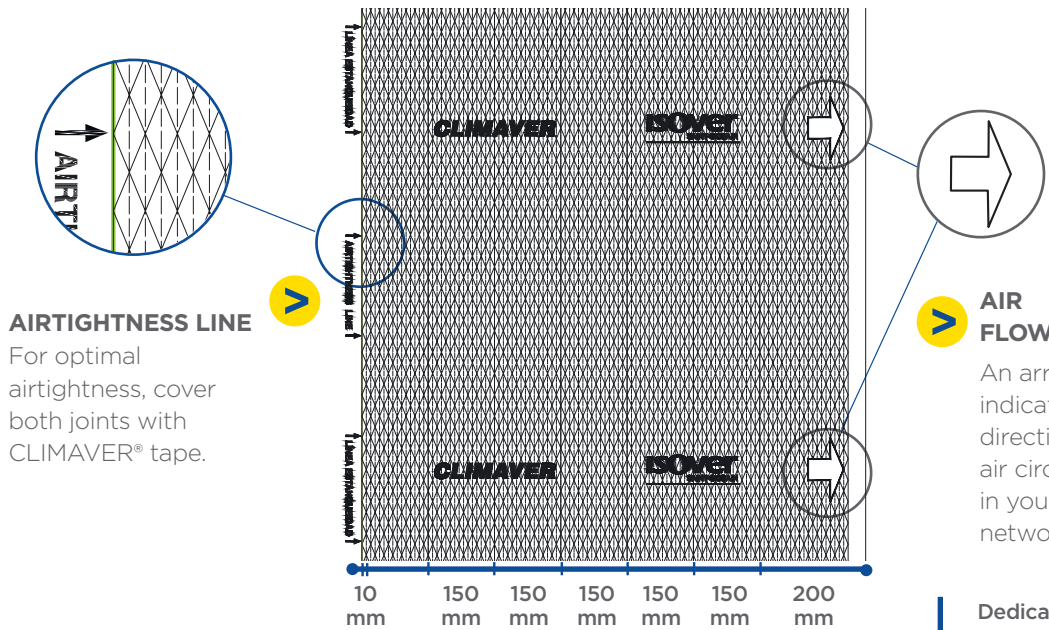

AIRTIGHTNESS LINE
 For optimal airtightness, cover both joints with CLIMAVER® tape.

AIR FLOW
 An arrow indicates the direction of the air circulating in your duct network.

RULE MTR 3
 No need to measure by hand - we have marked every 10mm.

Dedicated tool:
 for example Red MM tool for straight cut

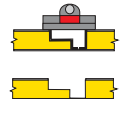

More information about the CLIMAVER® Straight Duct Method?
 Take a look at the **CLIMAVER® Installation Guide** or download our **CLIMAVER.app**.



GET MORE FROM SDM

With our exclusive leaning shiplap, you can further optimise the performance of your ductwork:

- **Improve airtightness & reduce pressure loss**
- **Enhance aesthetics**
- Obtain **stronger, more precise jointing**
- **Choose your configuration**, including complex shapes
- **Connect to any HVAC** standard equipment

0% waste with SDM



Example:
waste generated
creating two 90° elbows of
300x350mm

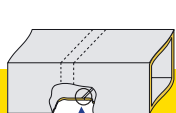
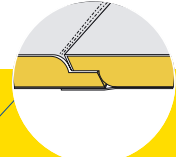

	
1.5 m²	Cut from 4 pieces
0 m²	Straight Duct Method

All complex shapes and connections needed with other HVAC equipment are easy to achieve with CLIMAVER®.

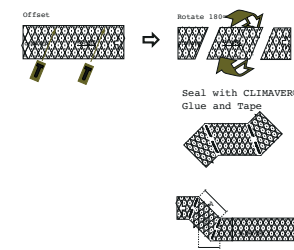
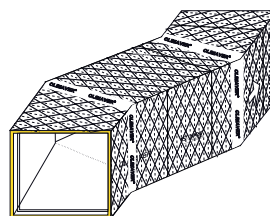
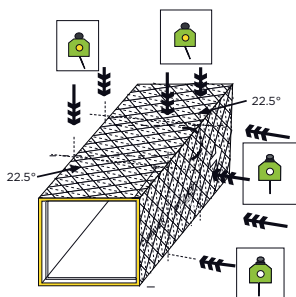
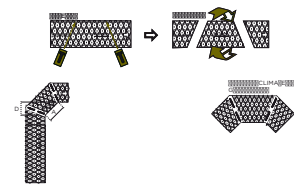
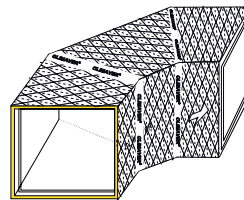
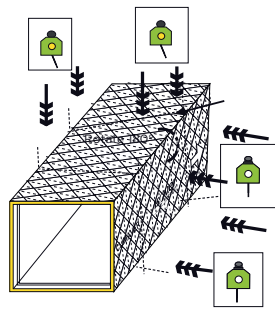

WHICH CLIMAVER[®] PRODUCT IS RIGHT FOR YOUR PROJECT?

Make your choice from a comprehensive range of solutions, trusted by customers around the world

A comprehensive range TO MEET ALL YOUR NEEDS

Whether you are looking for maximum energy efficiency, enhanced noise reduction or extra fire protection, you'll find a pre-insulated duct solution tailored to your project.

Product	Specifically designed for	Acoustic absorption	Thermal savings	Air-tightness	Thickness
CLIMAVER® PLUS R		*	**	***	25mm
CLIMAVER® NETO	Acoustics	**	**	***	25mm
CLIMAVER® A2 PLUS		*	**	***	25mm
CLIMAVER® A2 NETO	Acoustics	**	**	***	25mm
CLIMAVER® A2 DECO	Aesthetics + acoustics	**	**	***	25mm
CLIMAVER® APTA	Top class acoustics + energy savings	***	***	***	40/(50) mm
CLIMAVER® A2 APTA	Top class acoustics + energy savings	***	***	***	40mm
CLIMAVER® A1 APTA	Top class acoustics + energy savings	***	***	***	40mm
CLIMAVER® STAR	Outdoor use + acoustics	***	***	***	40mm

* good **better ***best



CLIMAVER® PLUS R
CLIMAVER® A2 PLUS

CLIMAVER® NETO
CLIMAVER® A2 NETO
CLIMAVER® APTA
CLIMAVER® A2 APTA
CLIMAVER® A1 APTA

CLIMAVER® A2 DECO

CLIMAVER® AND BIM:

We provide BIM objects of different CLIMAVER® configurations, to facilitate the work of designers and specifiers on projects involving Building Information Modelling. The BIM objects are available for download in the "Documentation" section of our website.

Proven Across CONTINENTS AND BUILDING SECTORS

CLIMAVER® solutions have been chosen by customers across the globe looking to combine high performance and significant cost savings in a variety of sectors:

- › Commercial buildings
- › Residential buildings
- › City complexes / malls
- › Airports
- › Hotels
- › Hospitals
- › High-rise buildings
- › Schools and educational institutions

BE CONFIDENT: A SYSTEM USED WIDELY FOR MORE THAN 50 YEARS

More than 180 million m² of CLIMAVER® duct have already been installed worldwide.



OFFICE

Beijing,
Chaoyang Distric
China



HOSPITAL

San Juan de Dios Hospital
Cordoba
Spain



SPORT

Arena Mineirão
Belo Horizonte
Minas Gerais
Brazil

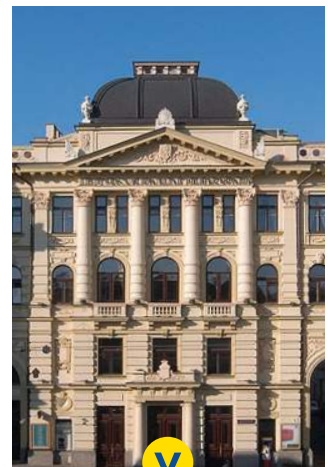

CULTURE

Lithuanian National
Philharmonic Hall
Vilnius
Lithuania

The CLIMAVER® STORY

For 50 years, we have constantly updated and improved the CLIMAVER® range to meet our customers' evolving needs. Based on this deep sector experience, we have constantly improved our manufacturing techniques to build a product optimised for both installers and end users.

DID YOU KNOW...?

Many first-generation CLIMAVER® installations are still operational.

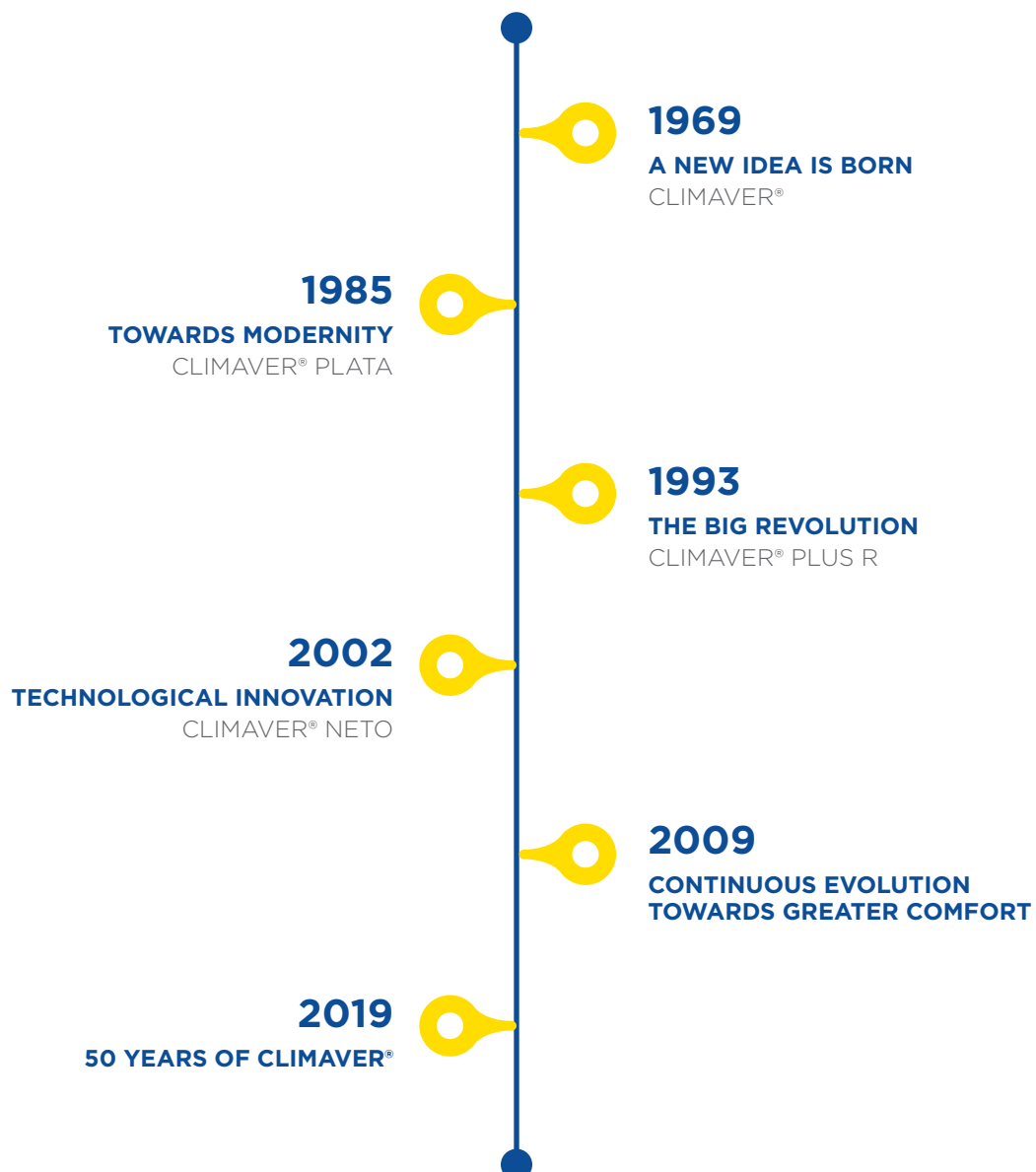

ABOUT US

Discover the Saint-Gobain Group,
and read more about ISOVER,
the world leading supplier
of sustainable insulation solutions

About US

SAINT-GOBAIN

Saint-Gobain designs, manufactures and distributes materials and solutions that improve the comfort of each of us and the future of all. Saint-Gobain products are found everywhere in our daily lives: from the home to the office, in cars and infrastructure, and high-performance materials for health and many industrial applications.

The Group aims to meet today's individual requirements for comfort, performance, safety, aesthetics. It also aims to take up the collective challenges of the future, from construction to sustainable mobility, from population growth to climate change.

In this way, Saint-Gobain continues to write the history of a company dating back more than 350 years, continuously improving its products, processes and services in a spirit of openness and attentiveness to customer needs.

As one of the top 100 industrial groups in the world and one of the 100 most innovative companies, Saint-Gobain continues to deploy its technological know-how, often in partnership with the most prestigious universities and laboratories.

With 2018 sales of €41.8 billion, Saint-Gobain operates in 67 countries and has more than 180,000 employees.

ISOVER

ISOVER creates efficient thermal and acoustical insulation solutions to design energy efficient constructions, to provide safe comfort for users and to help protect the environment.

As the world leading supplier of sustainable insulation solutions for all major application areas in both residential and non-residential buildings, ISOVER has drawn attention to the importance of effective insulation in the technical areas, such as Marine, Industry, HVAC and Original Equipment Manufacturers (OEM), where effective insulation is not only important for saving energy, but also for providing fire safety, acoustic and thermal comfort.

Our strategy is global but its implementation remains local, based on our strong local presence.



Saint-Gobain ISOVER
Les Miroirs
18 avenue d'Alsace
92096 PARIS
LA DEFENSE - Cedex France
www.isover.com

The information given in this brochure is based on our current knowledge and experience. If any information is incorrect this is not deliberate or grossly negligent. However, this document is not continually updated, and we cannot be held responsible for any unintentional errors. For the most up-to-date information, please visit our website: www.isover-technical-insulation.com